

## D30 INSTALLATION INSTRUCTIONS

### IMPORTANT

Strong springs aid the operation of these ladders! Care must be exercised during installation and operation so these springs are not released in an uncontrolled manner as this could lead to damage to the ladder and personal injury to the operator/installer.

These instructions are not intended to be a complete lesson in the installing of attic ladders but a procedural guide to competent tradespeople or DIYers.

### TOOLS REQUIRED

The timbertight screws supplied with this ladder require a 5/16" socket for easy installation. This can be used with a 9 volt (or stronger) battery drill or a standard power drill. Apart from this, only standard carpentry tools are required.

### CHOOSING THE LOCATION

When choosing the location for the installation of the attic ladder, a compromise between where you would like it to be located in relation to the floor plan and what is possible in relation to the roof structure may be required. The considerations for this compromise are:

- » Choose a location that will give good head room at the top of the ladder;
- » Choose a location with good access at the bottom of the ladder;
- » Choose a location that will allow for movement around the ladder when in the down position;
- » Allowance must be made for the operation of the ladder, as it requires a greater space to open than indicated by the opening in the ceiling (figure 1);

Model	Required Opening	Landing Space	Projection
D30	1460mm x 660mm	1769mm	2020mm

- » The area for the opening must be clear of wiring, plumbing and structural members such as beams and trusses with a minimum clear height above the ceiling of **399mm (figure 2)**.

### PREPARING THE OPENING

1. Mark out on the ceiling the opening required for the model ladder purchased in the selected position. Cut out the ceiling lining ensuring that the opening is square.
2. Using timber of a compatible size to the existing ceiling framing (ie 90mm x 45mm or 140mm x 45mm H1.2 treated, machine gauged radiata pine), frame up the opening. It may be necessary to cut through some existing ceiling joists to achieve the required size. Ensure these are properly supported during and after cutting. Three possible arrangements are shown in figures 3, 4 & 5.
3. **Do not cut trusses** without engineering approval.

Figure 6

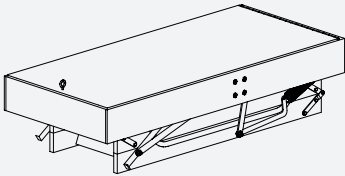

Figure 7

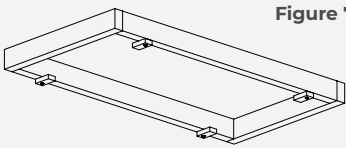

Figure 8

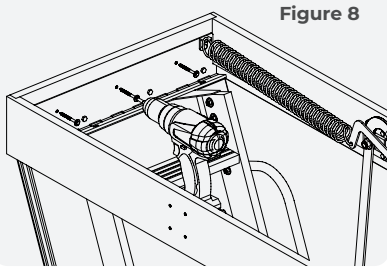
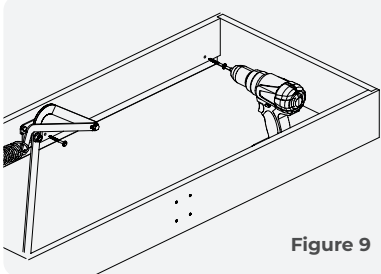

Figure 9



## PREPARING THE LADDER

1. Remove the ladder from its packaging and place it lid down on a bench or saw stool. The lid is less likely to get damaged there than laying it on the ground, as well as being better for your back!
2. Turn the ladder over so the lid is facing up. Fit the screw eye 25mm in from the opening end, midway across the width (figure 6).

## INSTALLING THE LADDER

1. Screw four temporary cleats approx 80mm x 40mm into your timber frame (figure 7). Ensure cleats can be rotated.

**The cleats must be securely fixed as they carry the full weight of the ladder.**

Note: If the ladder is to be installed before the ceiling lining is in place, the cleats must be packed down the thickness of the intended ceiling lining.

2. Lift the ladder through the opening into the attic space. Then lower down squarely into the opening so the lid of the ladder rests on the temporary cleats. This is normally best done from below. For safety and ease it is highly recommended that two people complete this step. Rotate the cleats off the lid and onto the frame of the ladder.
3. Check and confirm there is plenty of frame sitting on the cleats before proceeding further. Adjust if necessary. The ladder must not be allowed to fall, as this could cause **serious physical injury**.
4. Carefully open the ladder, checking that the frame remains securely on the cleats. Adjust if necessary. **Do not put any weight on the ladder at this stage.**
5. From a step ladder or work platform (not the attic ladder), fix the hinge end of the ladder to the ceiling framing through the pre-drilled holes in the hinge plate (figure 8). Use the timbertight screws supplied. Do not fit tight yet.
6. Carefully close the ladder and check if square. Wedges or packers may be needed at one side of the hinge strip to square the unit in the opening. This may require reopening the ladder and loosening or tightening one of the screws a little.
7. With the ladder open, pre-drill two 6mm holes in each side of the attic ladder frame making sure there is solid timber behind. Screw through the pre-drilled holes into the ceiling frame (figure 9). Do not fit tight yet.
8. Remove temporary cleats.
9. Carefully close the ladder and check that the ladder frame is showing around the frame and the ceiling frame. Make sure the sides stay plumb and straight.
10. Now tighten all screws and check again.

Figure 10

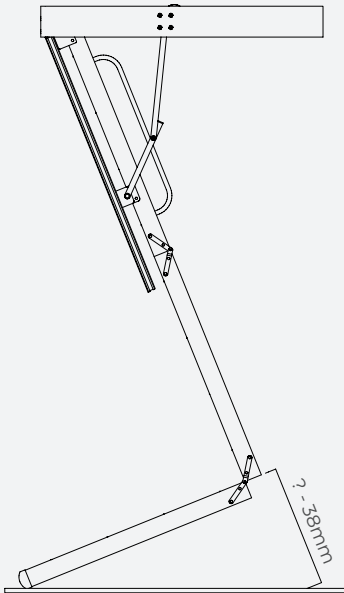

### ADJUSTING THE LADDER HEIGHT

1. With the top and middle sections of the ladder open and the bottom section tucked in behind, measure the distance from the bottom of the middle section, to the floor at the same angle as the ladder (figure 10). Do this on both sides.
2. Once you have determined the length of '?' (figure 10), deduct 38mm. Transfer these measurements to the front of each side of the bottom section of the ladder. Cut at 90 degrees. You may wish to remove the bottom section to complete this step.
3. Fix the rubber feet to the bottom of the ladder with the screws provided (figure 11).

### FINISHING THE LADDER

1. Fix a suitable architrave around the lid leaving a 2-3mm gap (figure 12).

Note: The ladder is designed to be installed with the bottom of the frame flush with the underside of the ceiling lining. An architrave will cover the gap between the ladder frame and the ceiling lining while also hiding the edge of the lid from view (figure 13).

Figure 11

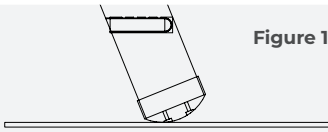

Figure 12

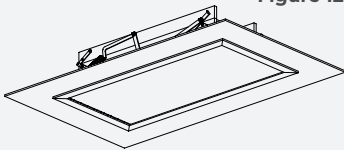
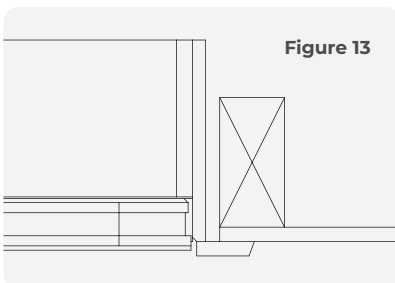
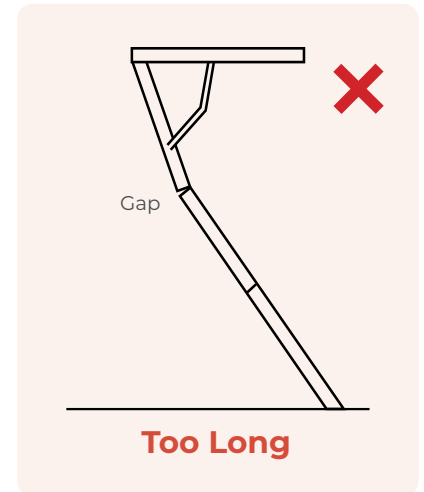
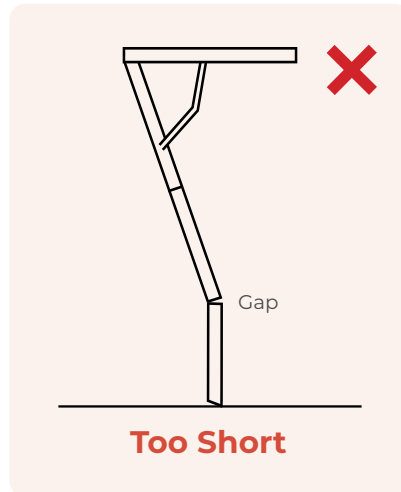
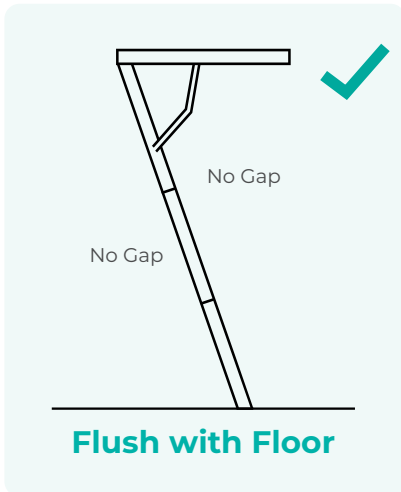

Figure 13



## HOW TO LOOK AFTER & USE YOUR AMSTEL ATTIC LADDER

1. Before climbing, make sure the ladder is fully extended and that there are no gaps between the ladder sections.



2. If your attic ladder has not been installed in accordance with the manufacturer's installation instructions your warranty may be void.
3. Lubricate all pivot points on your attic ladder at least once a year. If your attic ladder is used more than three times a week, lubricate every 4-5 months.
4. Face the ladder when you are climbing up and down.
5. Do not leave young children unattended while ladder is folded down.
6. If you have any concerns about your Amstel attic ladder, or it is damaged in any way please call 1300 207 178.